



Static Analysis of Equal Two Span Cable Stayed Bridges with Various Shapes of Pylons

التحليل الاستاتيكي للكباري الملجمة المحتوية علي بحرين متساويين مع اشكال متعددة للأبراج

Y. E. Agag, M. Naguib, Mohamed E. El Madawy and AyaAboElnaga

KEYWORDS:

Cable stayed bridges, pylons, floor beams

المخلص العربي: - الآن مع وجهة نظر العالم ، أصبح مجال الكباري ذات الكابلات مهم جدا. هذا البحث يهتم بدراسة الكباري ذات الكابلات المحتوية على بحرين مع اشكال متعددة للبرج. تم الاخذ في الاعتبار ثلاثة أنواع من هذه الكباري وهي المروحية والاشعاعية والقيثارية . التحليل الاستاتيكي تم للتمثيل الرياضي للكابلات ثنائية المستوى نظراً للمعاملات التي تؤثر على الاستجابة. تتضمن هذه المعاملات: تغيير شكل البرج وتغير نسبة ارتفاع البرج إلى اتساع الكوبري، الوصلات المختلفة بين الأبراج وكمرات الأرضية ، شكل ترتيب الكابلات ، الشد المبدئي في الكابلات، وحالات التحميل المختلفة لكمرات الأرضية. تم إجراء التحليل بواسطة برنامج الفورتان على أساس تصغير طاقة الوضع باستخدام طريقة التحدرات المتبادلة

Abstract— Now with new world view, the field of cable stayed bridges become very important. This paper is concerned about the study of two spans cable stayed bridges with various shapes of pylon. Three types of these bridges as fan, harp and radiating shapes are considered. The static analysis is carried out for mathematical models with double plane of cables considering the parameters affecting the response. These parameters include: the variations of pylon shape, the variation of the height of the pylon to span of the bridge, different connections between pylons and floor beams, the arrangements of cables, initial tension of cables, and different cases of loading for floor beams. The analysis is done by a FORTRAN program based on the minimization of

total potential energy of the structure using the method of conjugate gradient [1].

I. INTRODUCTION

DURING the past few decades, cable-stayed bridges have found wide applications, especially in Western Europe, and to a lesser extent in other parts of the world. The renewal of the cable-stayed system in modern bridges engineering was due to the tendency of bridge engineers in Europe.

Cable stayed bridges consist of three principal components, namely floor, pylons, and inclined cables. The floor is supported elastically at points along its length by inclined cables so that can span a much longer distance without intermediate supports Fig. (1)[2].

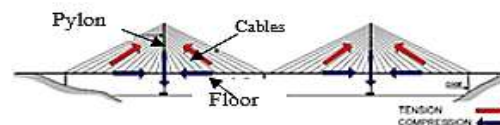

Fig.(1) : components of cable stayed bridge

Received: (10 October, 2018) - Revised: (5 March, 2019) - Accepted: (30 March, 2019)

Y. E. Agag, Emeritus professor in Determent of Structural Engineering, Faculty of Engineering, Mansoura University (e-mail: youssefagag@gmail.com)

M. Naguib, Emeritus professor in Determent of Structural Engineering, Faculty of Engineering, Mansoura University (e-mail: naguib2005@yahoo.com)

Mohamed E. El Madawy, lecturer in Determent of Structural Engineering, Faculty of Engineering, Mansoura University (e-mail: m_tantawy77@yahoo.com)

AyaAboElnaga, Demonstrator in Determent of Structural Engineering, Faculty of Engineering, Mansoura University (e-mail: ayaaboelnaga@mans.edu.eg.com)

Several cable-stayed bridges have been constructed with different shape of pylons such as H-shaped, A-shaped, Diamond shaped, Inverted Y-shaped, etc Fig. (2). Which results in a great demand to evaluate the effects of different shapes of pylon on cable stayed bridges under the consideration of static load. Pylon shapes depend on the loading especially the lateral loads, manufacturing materials, architectural form and construction implementation site.

Portal pylons were used in the design of early cable-stayed bridges, as in the case of suspension bridges, where the portal pylons were commonly used to obtain stiffness against the wind load which the cable transfers to the pylons. However, later investigation of cable-stayed bridges indicated that the horizontal forces of the cables were in fact, relatively small, so that freely standing pylon legs could be used without disadvantage. The inclined stay cables even give a stabilizing restraint force when the top of the pylon is moved transversely with single pylons or twin pylons with no cross-member, the pylon is stable in the lateral direction if the level of the cable anchorages is situated above the level of the base of the pylon [3].



Fig.(2) : Examples for pylon Shapes

Energy method is applied to the analysis of general pin ended truss and cable structures. Both geometric and material nonlinearities are directly incorporated within the formulation, there by accounting for large displacement and strains as well as configuration changes due to the structural response [4].

By their structural behavior, cable-stayed systems occupy a middle position between the girder type and suspension type bridges. The main structural characteristic of this system is the integral action of the stiffening girders and prestressed inclined cables, which run from the pylon tops down to the anchor points at the stiffening girders. Horizontal compressive forces due to the cable action are taken by the girders and no massive anchorages are required. The substructure therefore is

very economic. With the orthotropic type deck, however, the stiffened plate with its large cross-sectional areas acts not only as the upper chord of the main girders and of the transverse beams, but also as the horizontal plate girder against wind forces, giving modern bridges much more lateral stiffness than the wind bracings used in old systems. In fact, in orthotropic systems, all elements of the roadway and secondary parts of the superstructure participate in the work of the main bridge system. This results in a reduction in the depth of the girders and economy in the steel structure [5].

A further important characteristic of such a three-dimensional bridge is the full participation of the transverse structural parts in the work of the main structure in the longitudinal direction. This means that a considerable increase in the moment of inertia of the construction, which permits a reduction in the depth of the girders and a consequent saving in steel. The orthotropic system provides the continuity of the deck structure at the pylons and at the center of the main span. The continuity of the bridge superstructure over many spans has many advantages and is necessary for a good cable-stayed bridge. Considering the range of applications in the domain of highway bridges, cable-stayed bridges fill the gap that existed between deck type and suspension bridges. Orthotropic deck plate girders showed superiority over other systems in the case of medium spans. For long spans, however, they required considerable girder depth. The cable stayed bridge provides a solution to this problem, based on a structural system comprising an orthotropic plate deck and a continuous girder.

The total potential energy (W): [10]

The total potential energy of a structure may be written as:

$$W = U + V \tag{1}$$

Where U is the elastic or strain energy stored in the structure and V is the potential energy of the loading. The total potential energy may also be expressed

as:

$$W = U_f + U_P + V \tag{2}$$

Where U_f (is the strain energy stored in the flexural elements such as columns and beams and U_P is the strain energy stored in pin-jointed members and cables

$$w = \sum_{n=1}^f \sum_{s=1}^{12} \sum_{r=1}^{12} \left(\frac{1}{2} \bar{x}_s k_{sr} \bar{x}_r \right)_n + \sum_{n=1}^P \left(U_0 + T_0 e + \frac{EA}{2L_0} e^2 \right)_n - \sum_{n=1}^N F_n x_n \tag{1}$$

Where

1. F = Number of flexural members;
2. P = Number of pin-jointed members and cable links;
- X_n = Element in displacement vector due to applied load only.
3. X_s or X_r = Element of the displacement vector of a flexural member including an effect of the pretension in the cables;
4. K_{sr} = Element of stiffness matrix in global coordinates of a flexural member;
5. U_0 = Initial strain energy in a pin-jointed member or cable link due to pretension;

6. T_0 = Initial force in a pin-jointed member or cable link due to pretension;
 7. ΔT = Increment in force in a pin-jointed member or cable link due to applied loads only;
 8. F_n = Element in applied load vector;
 9. N = Total number of degrees of freedom of all joints;
 10. L_0 = the unstrained initial length of the pin-jointed member or cable link;
 11. E = Modulus of elasticity;
 12. e = Elongation of pin-jointed members or cable links due to applied load only;
- Gradient vector $[g]$

$$[g_i]_n = \sum_{n=1}^{f_n} \sum_{r=1}^{12} (k_{nr} x_r)_n + \sum_{n=1}^{P_n} \left(T_0 + \frac{EA}{L_0} e \right)_n \left[\frac{\partial e_n}{\partial x_i} \right]_n - [F_i]_n \quad (2)$$

II. PROGRAM VERIFICATION [14]

Tezcan [13] analyzed the space frame shown in Fig. (3). He used a Newton-Raphson iteration scheme to achieve a solution tangent to the deflection curve. Tables (1), (2), and (3) indicate a good agreement between Tezcan’s work and the present method. The results also show that the proposed method is more efficient since the cable element has fourth order convergence during all iterations

TABLE 1
PROPERTIES OF SECTION USED

Columns	Cables
$I_x = 0.00275 \text{ m}^4$	$I = 0$
$I_y = 0.000982 \text{ m}^4$	$A = 0.00129 \text{ m}^2$
$J = 0.0000993 \text{ m}^4$	
$A = 0.08081 \text{ m}^2$	$E = 2.0682 \times 10^{11} \text{ N/m}^2$

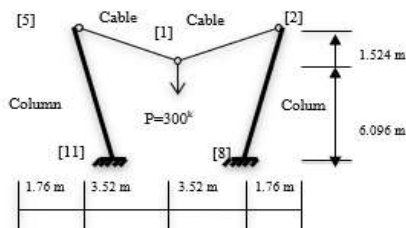
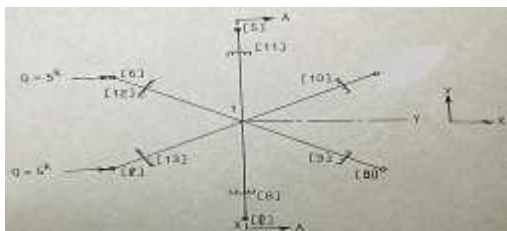

Fig. (3). A Space frame data



Elevation A-A

TABLE 2
DISPLACEMENTS FOR FRAME (TEZCAN) [13]

Joint Number	Deflection, in mm				
	Axes	Cycle Number			
		1	2	3	4
1	Y	0.2761	0.2649	0.2819	0.2821
	Z	68.3730	52.9780	44.1498	43.3958
5	X	19.2854	17.9491	14.5446	14.3061
	Y	0	0.0124	0.0262	0.0278
6	Z	4.4349	3.9072	3.2050	3.1468
	X	9.0262	8.3378	6.5623	6.4351
	Y	17.3794	16.2306	13.3417	13.1394
	Z	4.4993	3.9638	3.2657	3.2075

TABLE 3
DISPLACEMENTS FOR FRAME, REF. [8].

Joint Number	Deflection, in mm			
	Axes	Cycle Number		
		1	2	3
1	Y	0.2693	0.2818	0.2813
	Z	42.6980	43.2492	43.2356
5	X	14.1152	14.2931	14.2872
	Y	0.0220	0.0284	0.0281
6	Z	3.2429	3.1439	3.1426
	X	6.4934	6.4174	6.5623
	Y	12.8739	13.1342	13.1223
	Z	3.3078	3.2047	3.2022

III. ANALYSIS CONSIDERATIONS

1. SHAPES OF PYLONS.

With reference to Fig. (4), these shapes of pylons are considered.

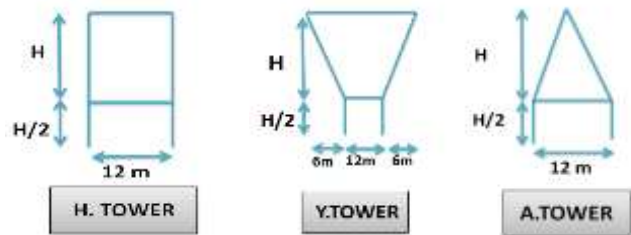

Fig. (4): Shape of pylons.

First, the static analysis is carried out for fan, radiating and harp bridges considering double plane of cables with pylons having H-shape. All types of bridges have an equal span of 135m as shown in Figs (5a), (5b) and (5c), respectively.

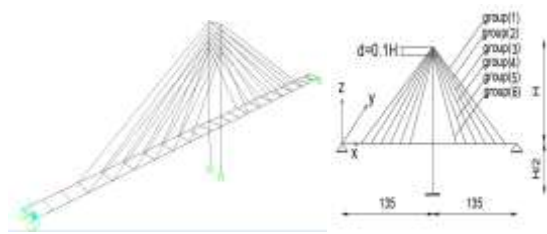

Fig.(5a): Fan Bridge.

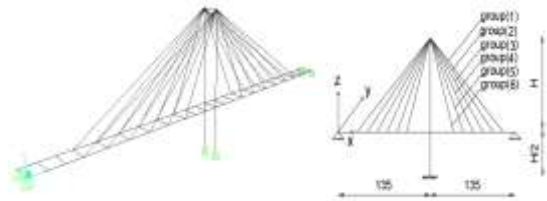

Fig.(5b): Radiating Bridge.

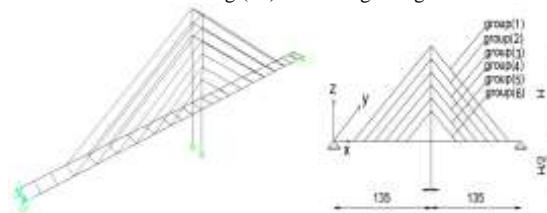

Fig.(5c): Harp Bridge.

Fig (5): Type of Bridges using H-tower Type.

Finally, all work is repeated for Y-tower type as shown in Fig (7).

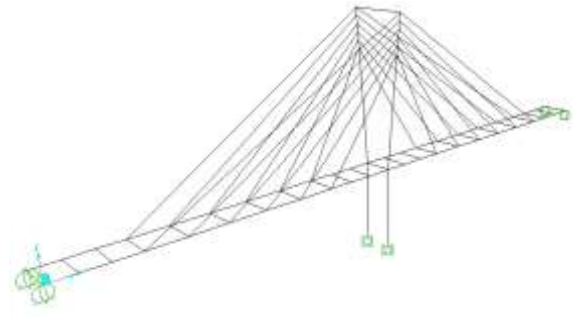

Fig.(7a): Fan Bridge.

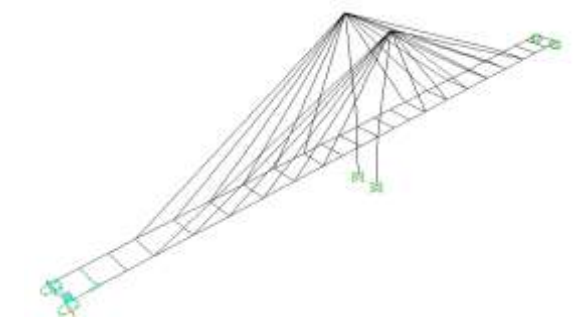

Fig.(7b): Radiating Bridge.

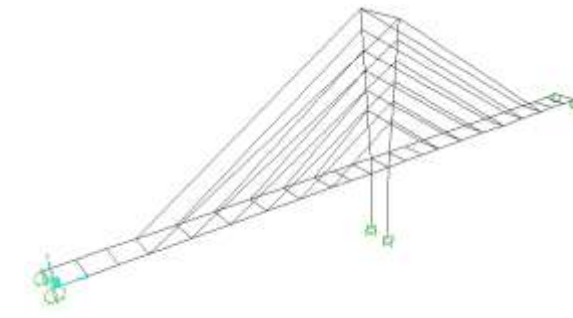

Fig.(7c): Harp Bridge.

Fig (7): Type of Bridges using Y-tower Type

Second, the analysis is carried out considering all assumptions mentioned in first for A-tower type instead of the H-shape. All three bridges for are shown in Fig (6).

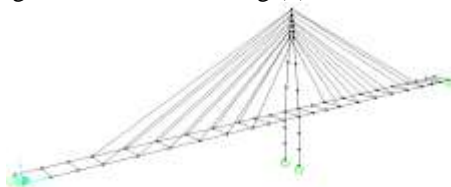

Fig.(6a): Fan Bridge.



Fig.(6b): Radiating Bridge.



Fig.(6c): Harp bridge

Fig (6): Type of Bridges using A-tower Type.

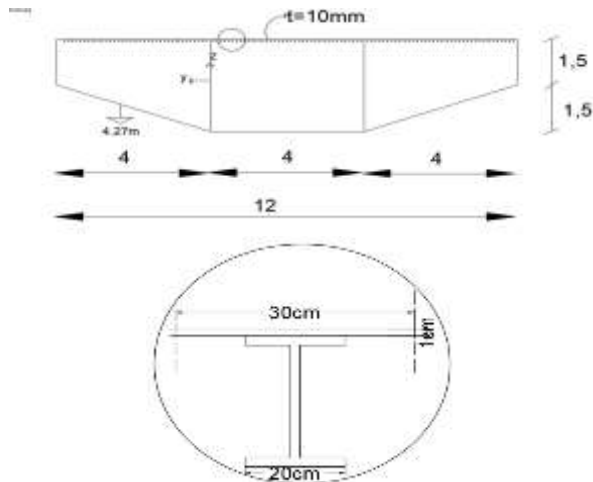

Fig. (8): Orthotropic Deck Cross Section.

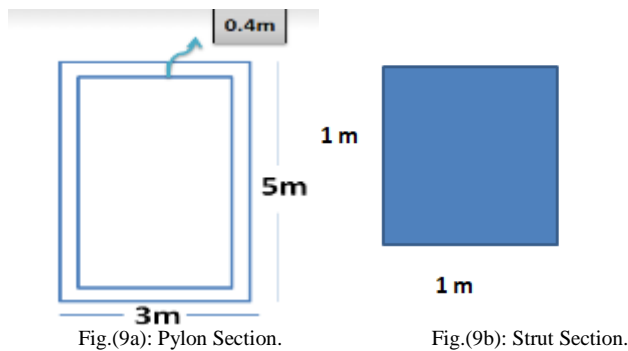

Fig.(9a): Pylon Section.

Fig.(9b): Strut Section.

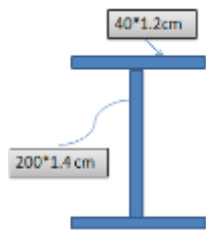

Fig.(9c): X-girder Section.

All mathematical models have six cables in each side of pylon, the cables were 6x37 classes IWRC (independent wire rope core) of zinc-coated bridge rope [6]. The cables have an area of 48.7741 cm², diameter of 10.16 cm, own weight of 39.34 kg/m, modulus of elasticity of 1584 t/cm² and maximum breaking loads of 730 tons. The pylon is designed as reinforced concrete with hollow rectangular uniform section having 3 m, width (parallel to X-axis) and 5 m depth (parallel to Y-axis) with thickness of walls as 0.4 m. The pylons own weight is 14.4 t/m. The decks were taken as steel box girder in orthotropic plate shape with longitudinal ribs [12]. The own weight including asphalt as 5 t/m for each main girder (D.L) The cross girders consist of built-up I-section with web plate 200x1.4 cm and two flange plate of 40x1.2 cm in each side [9]. The strut between pylons has a square reinforced concrete section with 1m. The cross section of the orthotropic deck floor, pylon, strut and X-girders are shown in Figs (8), (9a),

(9b) and (9c). Also, all properties for all bridge components are given in table 4.

TABLE 4
PROPERTIES FOR ALL BRIDGE COMPONENTS

	Area(m ²)	J(m ⁴)	I _x (m ⁴)	I _y (m ⁴)	E(t/cm ²)
Pylon section	5.76	15.9	17.66	7.52	300
Floor beam section	3.4	50.96	5.32	45.65	2100
Strut section	1	0.14	.0833	.0833	300
X-girder section	0.11	0.064	0.012	0.053	2100

2. CONNECTION BETWEEN PYLON AND FLOOR BEAMS.

Four cases of connection between pylons and floor beams as shown in Fig (10) are considered, while all end supports in both sides of the bridges are roller supports [6] [7].

- The connections between pylons and floor beam are rigid, while the pylon bases are fixed case (A).
- The intersection between floor beams and pylons are pinned, while the pylon bases are fixed, case (B).
- The lower parts of pylon are released, and the floor beam is continuous with rigid attachments with pylon on hinged support at middle, Case (C).
- The lower parts of pylon are released, and the floor beam is continuous with pin attachments with pylon on hinged support at middle, Case (D).

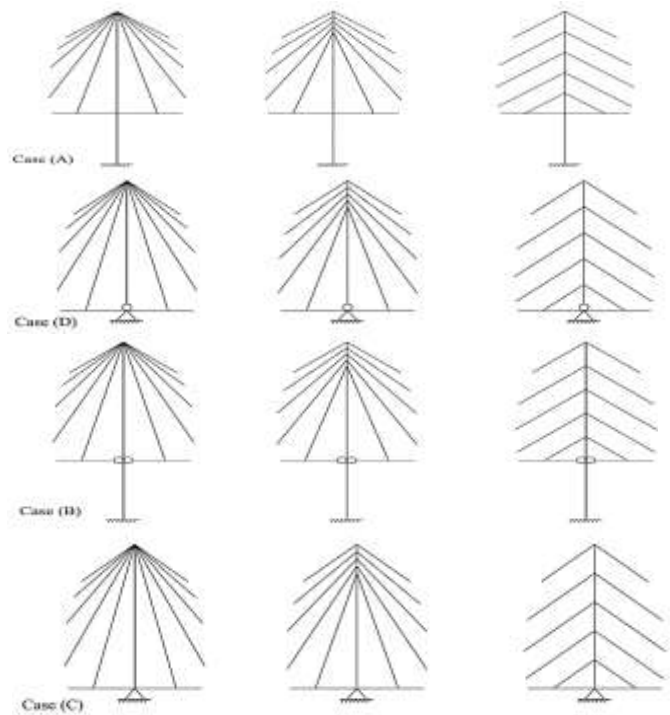

Fig. (10): Connection Between Pylon and Floor Beams.

3. Cases of loading.

Four cases of loading are taken into consideration for static analysis as following:

1. Case (1) = D.L
2. Case (2) = D. L+ L.L
3. Case (3) = D. L+ 0.5L.L
4. Case (4) = D. L+ 0.25L.L

D.L: The own weight of orthotropic deck floor including asphalt = 5 t/m'.

The static analysis for all considered cases is carried out with a uniformly distributed live loads (L.L) along spans lengths according to the case of loading with intensity of 5 t/m'. It's shown in Fig (11).

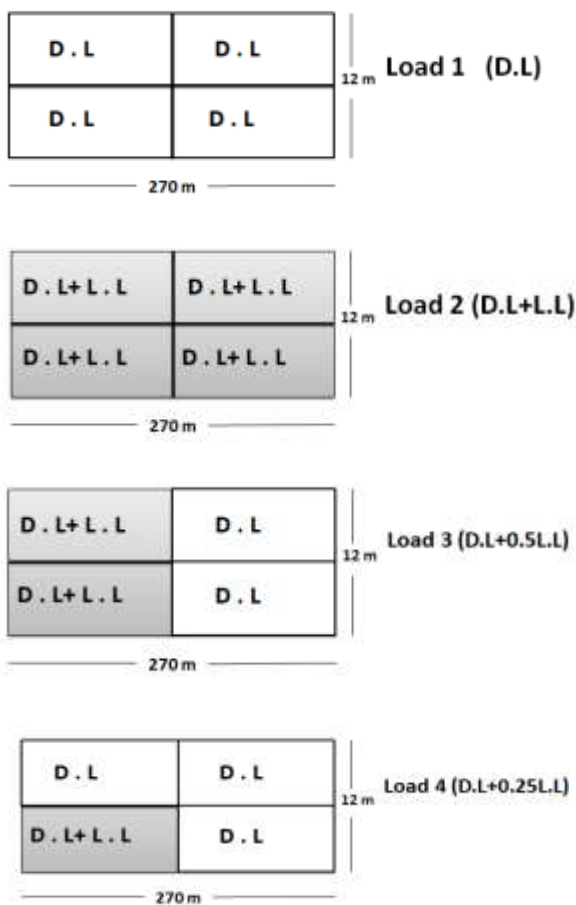

Fig. (11): Cases of Loading.

For cables [11].

The initial tensions of cables in all cases are taken as (38.5 tons, 73 tons, 144 tons) which represent (5%, 10%, 20% of maximum breaking loads) respectively.

IV. STUDY CASES

The following parameters in the static analysis are taken into consideration on:

1. Pylons shapes effect obtained results showed that:
 - a. There is no different between the three shape of pylons in case (1), case (2) and case (3) but the difference is shown in case (4) for the lateral movement in the pylon.
 - b. There is no effect of pylon shape on the response of floor beams.
2. Studying the effect of different case of loading on the floor beams response by cases of case (2), case (3) and case (4).
3. Effect of the connections between the pylon and floor beams (case A, case B, case C, case D) with the different arrangements of cables fan, radiating and harp.
4. Effect of pylons height, H, to span, L, ratio. The results showed that: taking in mind the results related to this part isn't included.
 - a. With increasing H/L ratio, the lateral movement in the pylon increases and the deflection in the floor beam decreases.
 - b. Also, an increasing of H/L causes a decrease in final tensions of cables.
 - c. For this study H/L is fixed at 0.6 with a corresponding height of 80m.
5. Effect of initial tension of cables. The results showed that: taking in mind the results related to this part isn't included.
 - a. An increasing the initial tension in cables, the lateral movement in the pylon and the deflection in the floor beam decrease.
 - b. For this study initial tension of cables is fixed at 10% of maximum breaking loads =73tons.

V. ANALYSIS OF RESULTS.

1. The previous results showed in different graphs Fig (12) to Fig (47).
2. he following Tables 5 and 6 shows the maximum values which confirmed.

TABLE 5
MAXIMUM SWAY VALUES FOR THREE SHAPE OF PYLONS IN X AND Y DIRECTIONS (M).

		Sway value (m)				
		Type of connection				
Shape of pylon	Type of bridge	Away direction	Case A	Case B	Case C	Case D
H tower	harp	X	-.0862	-.0396	-.0709	-.0538
		Y	-.0325	-.002	-.0142	-.0003
	fan	X	-.0903	-.041	-.0761	-.0614
		Y	-.0321	-.0011	-.01	-.0003
	radiating	X	-.0925	-.041	-.079	-.0644
		Y	-.032	-.0017	-.0143	-.0005
A tower	harp	X	-.0834	-.0369	-.0703	-.0533
		Y	-.0145	-.0058	-.0016	.001
	fan	X	-.0869	-.0378	-.075	-.052
		Y	-.0148	.0056	.003	-.0005
	radiating	X	-.0888	-.0371	-.0221	-.058
		Y	-.0398	-.0501	.0457	.0346
Y tower	harp	X	-.0884	-.0415	-.0715	-.0545
		Y	-.0426	-.014	-.0201	-.005
	fan	X	-.0926	-.0428	-.0768	-.0621
		Y	-.042	-.013	-.02	-.005
	radiating	X	-.0948	-.0423	-.0801	-.0654
		Y	-.0949	-.0812	-.0603	-.0375

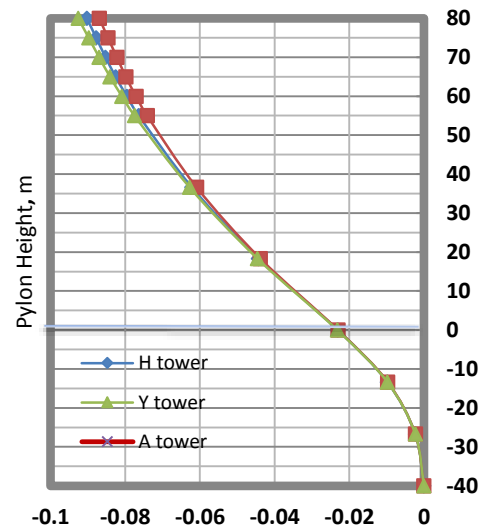

Fig. (12): Sway X, Case A, Fan.

TABLE 6
MAXIMUM DEFLECTION IN FLOOR BEAM (M).
Deflection for floor beams (m)

		Type of connection			
Load	Type of bridge	Case A	Case B	Case C	Case D
L.L (Load 2)	harp	-.1536	-.154	-.1476	-.1476
	fan	-.144	-.1439	-.1379	-.1379
	radiating	-.1403	-.1403	-.1342	-.1342
L.L (Load 3)	harp	-.2336	-.1743	-.2501	-.2216
	fan	-.2224	-.1662	-.237	-.219
	radiating	-.2172	-.1629	-.2305	-.2216
L.L (Load 4)	harp	-.1573	-.1247	-.155	-.1408
	fan	-.148	-.1173	-.1451	-.136
	radiating	-.1441	-.1141	-.1403	-.1359

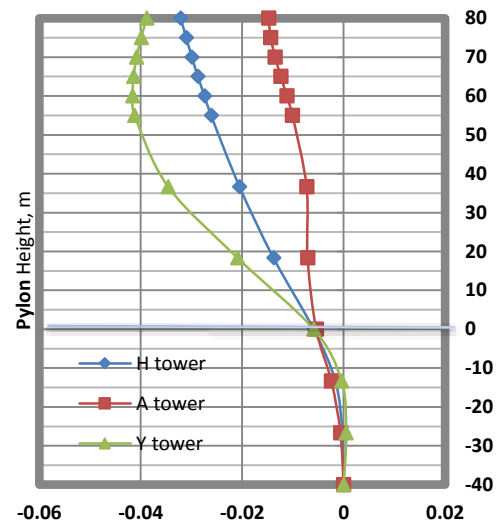

Fig. (13): Sway Y, Case A, Fan

VI. CONCLUSIONS.

The analysis of results of the two spans cable stayed bridges in this research, has led to the following conclusions:

1. A-tower pylon shape is better than H-tower and Y-tower in the lateral movement in the pylon.
2. The connection types between pylon and floor beam represents a big factor in the analysis. We can say connection cases B and D are better than connection cases A and C in all types of bridges shapes.
3. Radiating Shape Bridge is better than fan and harp bridges types.
4. Case of asymmetrical loads (case 3) causes a great deflection in the floor beam.

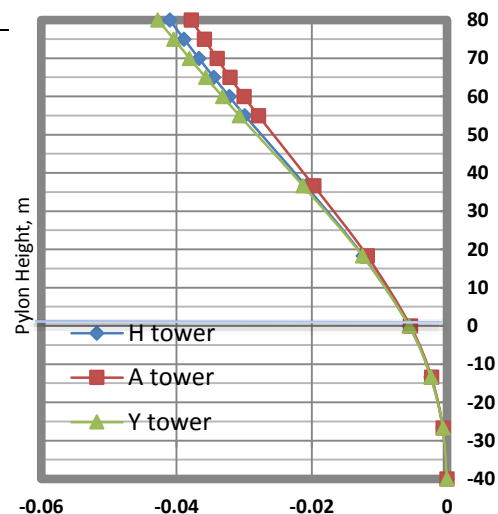

Fig. (14): Sway X, Case B, Fan.

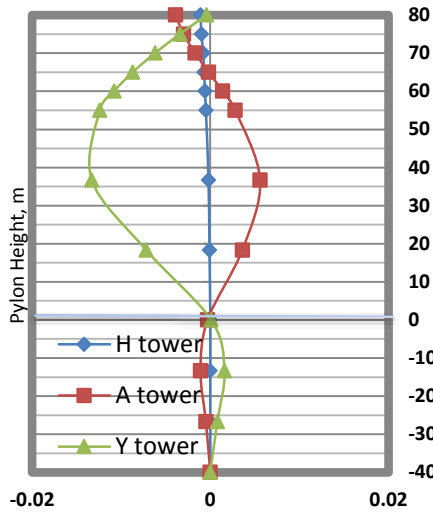

Fig. (15): Sway Y, Case B, Fan.

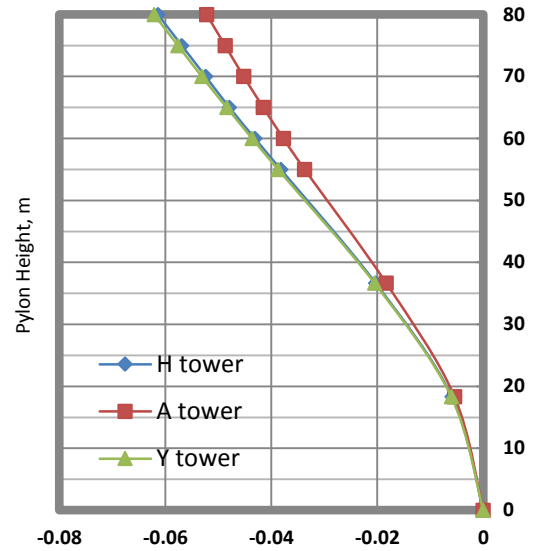

Fig. (18): Sway X, Case D, Fan.

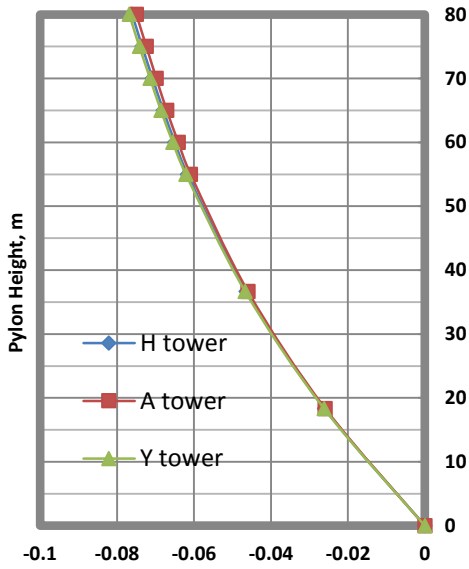

Fig. (16): Sway X, Case C, Fan.

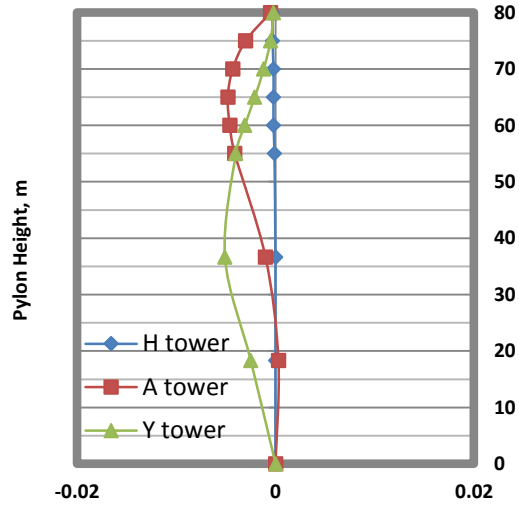

Fig. (19): Sway Y, Case D, Fan

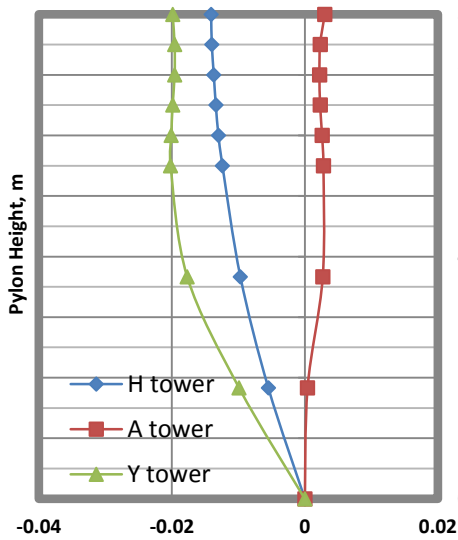

Fig. (17): Sway Y, Case C, Fan.

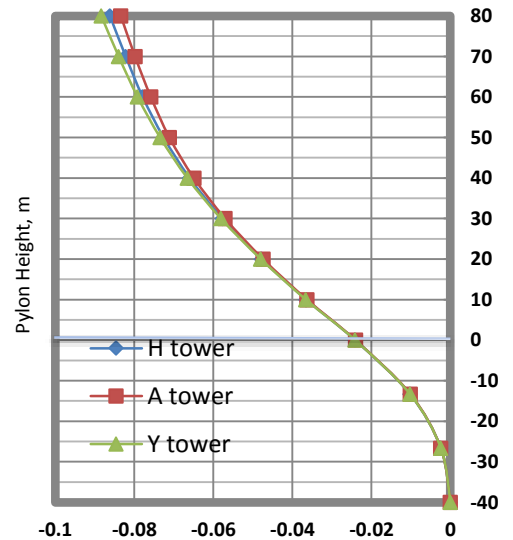

Fig. (20): Sway X, Case A, Harp.

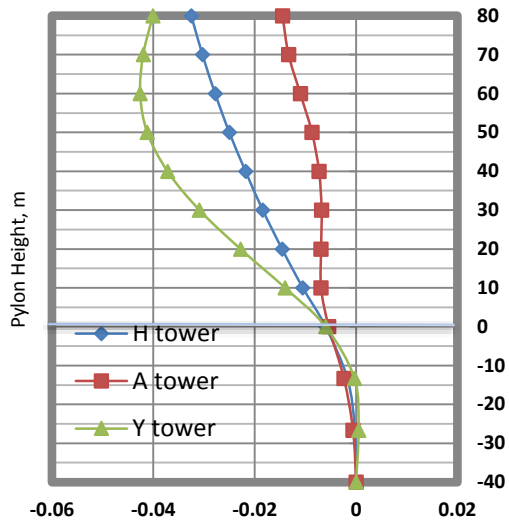

Fig. (21): Sway Y, Case A, Harp.

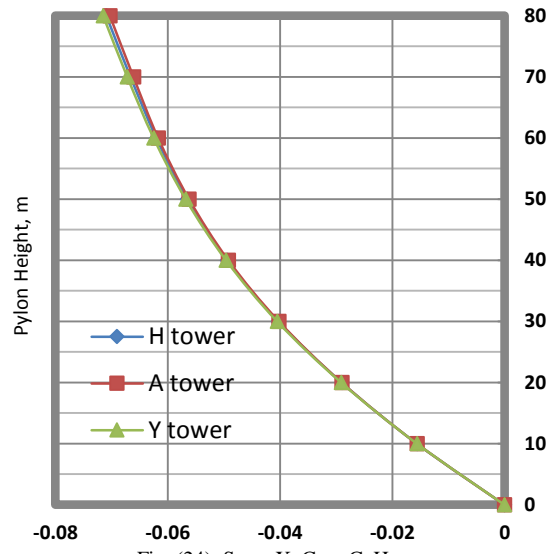

Fig. (24): Sway X, Case C, Harp.

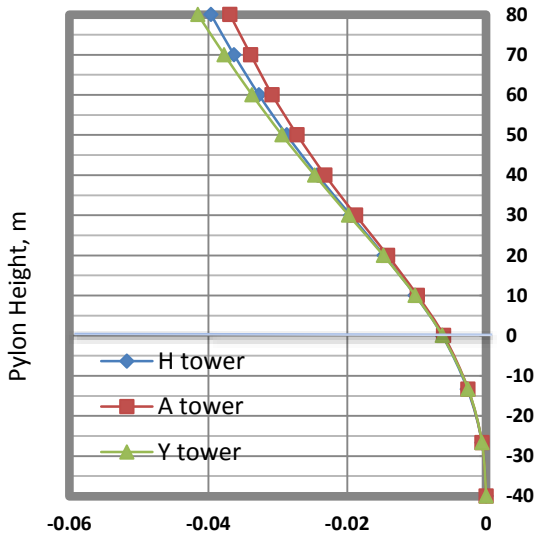

Fig. (22): Sway X, Case B, Harp.

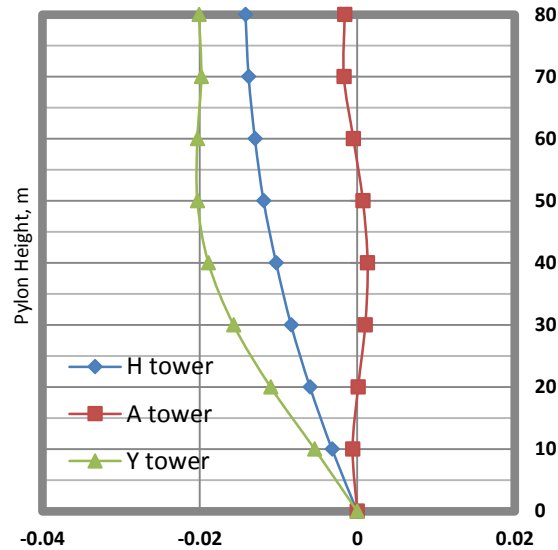

Fig. (25): Sway Y, Case C, Harp.

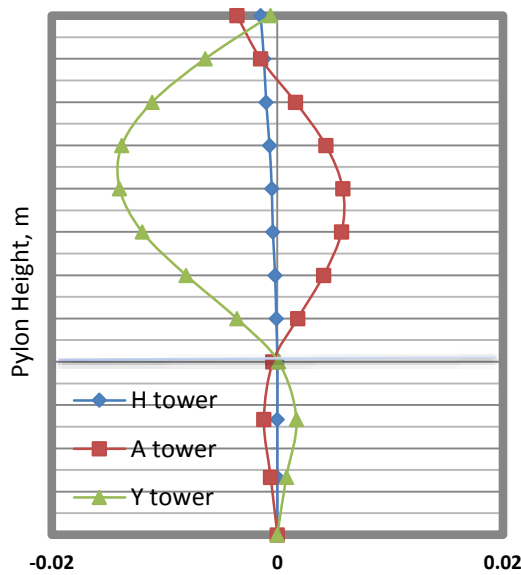

Fig. (23): Sway Y, Case B, Harp.

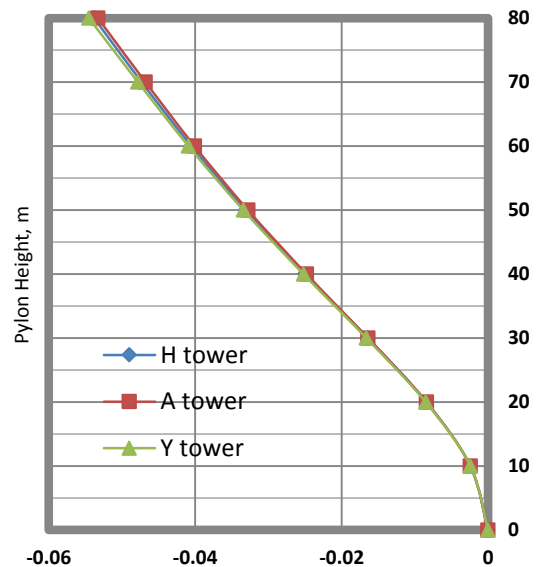

Fig. (26): Sway X, Case D, Harp.

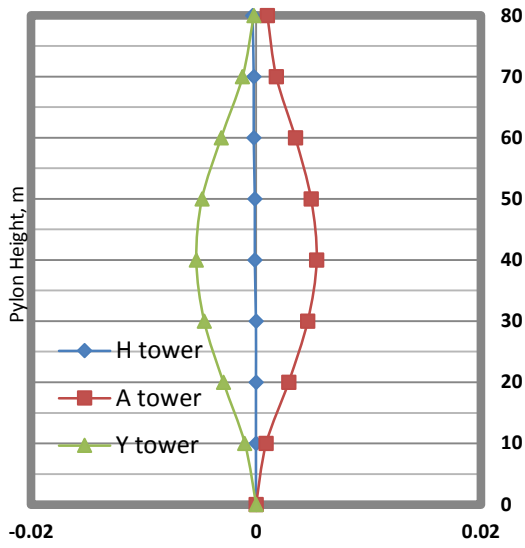

Fig. (27): Sway Y, Case D, Harp.

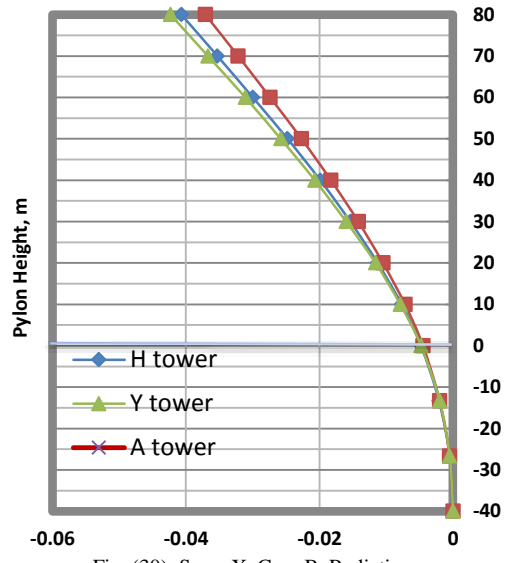

Fig. (30): Sway X, Case B, Radiating.

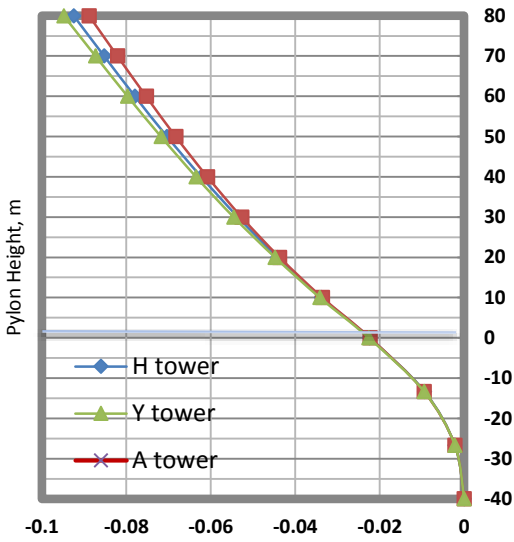

Fig. (28): Sway X, Case A, Radiating.

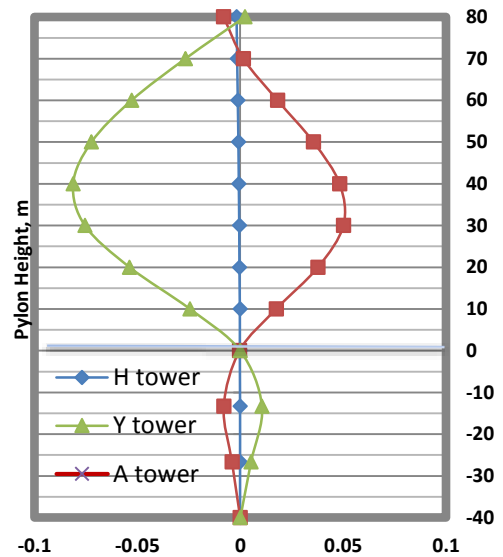

Fig. (31): Sway Y, Case B, Radiating.

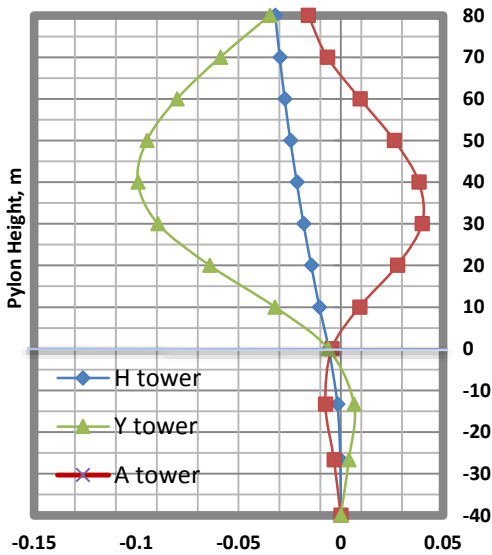

Fig. (29): Sway Y, Case A, Radiating.

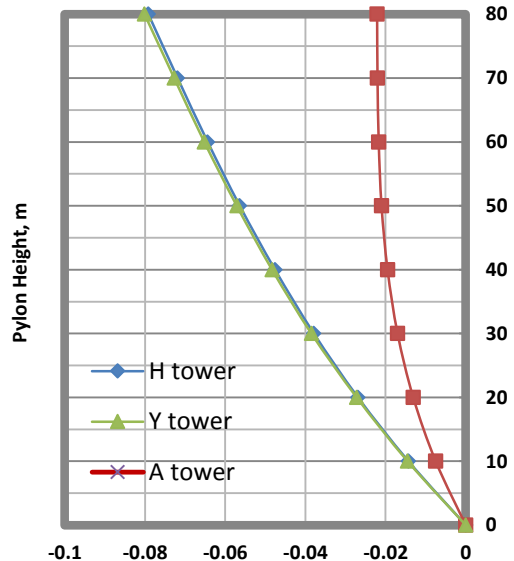

Fig. (32): Sway X, Case C, Radiating.

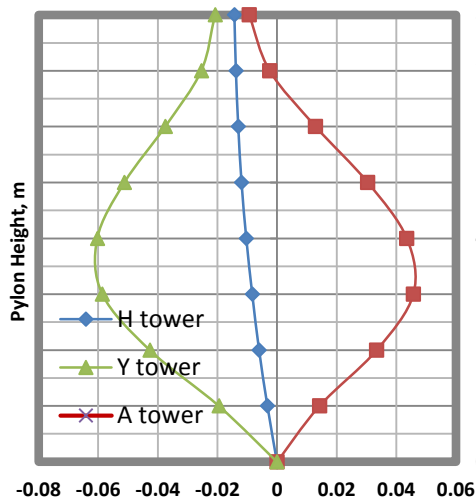

Fig. (33): Sway Y, Case C, Radiating.

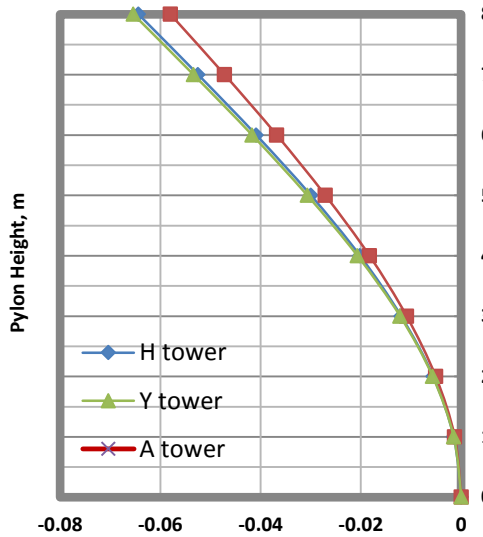

Fig. (34): Sway X, Case D, Radiating.

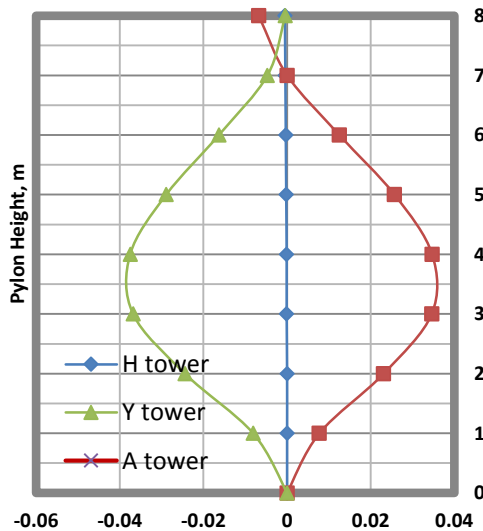

Fig. (35): Sway Y, Case D, Radiating.

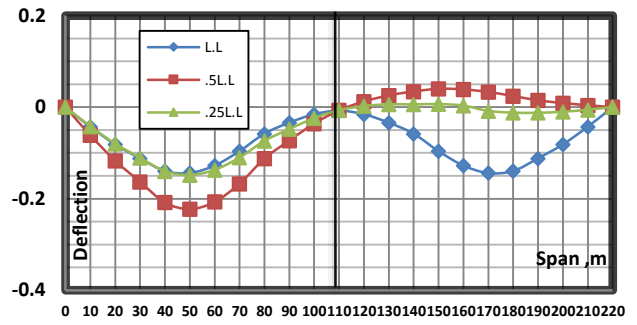

Fig. (36): Deflection, Case A, Fan.

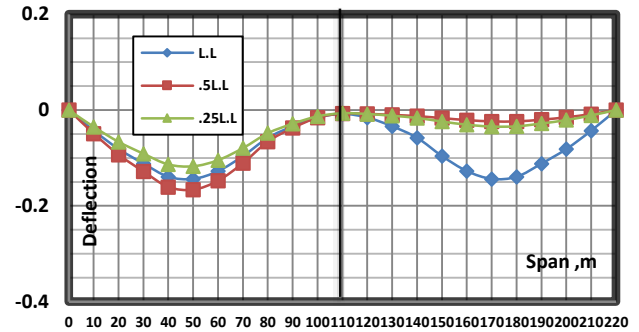

Fig. (37): Deflection, Case B, Fan.

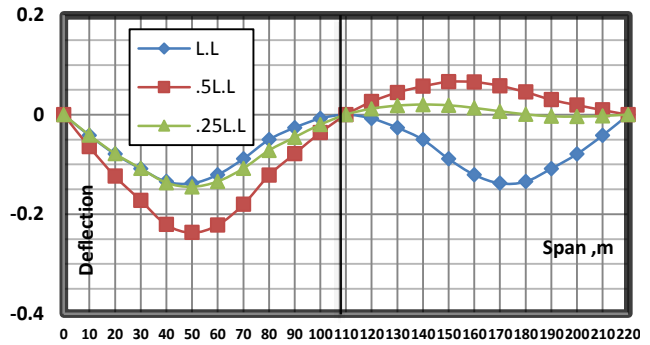

Fig. (38): Deflection, Case C, Fan.

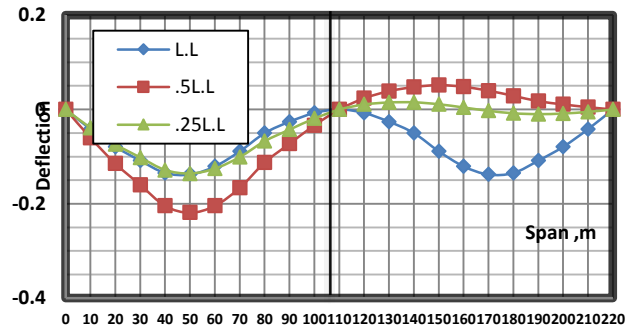

Fig. (39): Deflection, Case D, Fan.

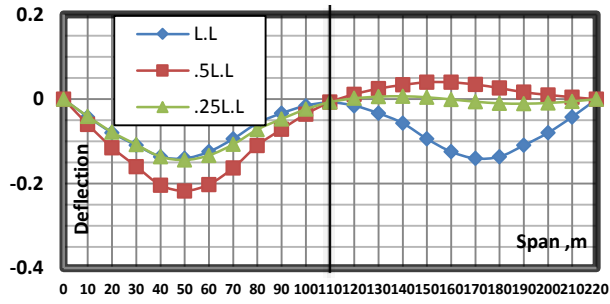

Fig. (40): Deflection, Case A, Radiating

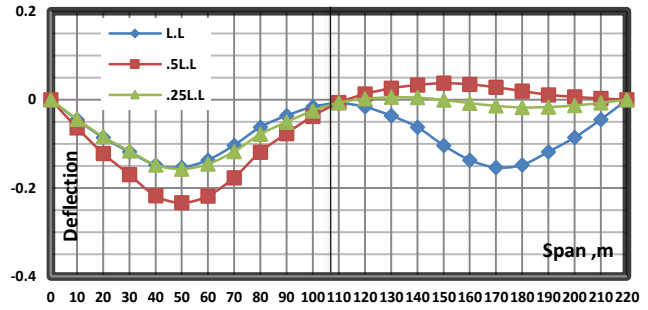

Fig. (44): Deflection, Case A, Harp.

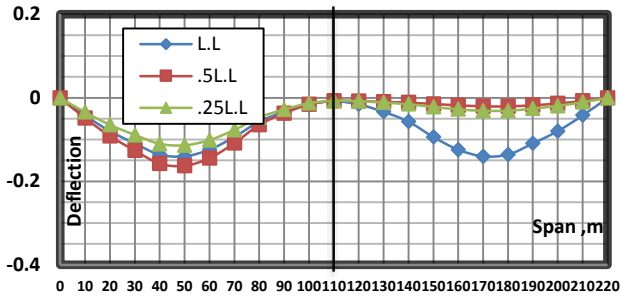

Fig. (41): Deflection, Case B, Radiating.

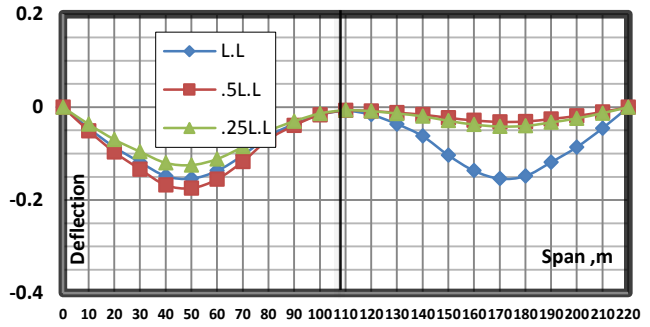

Fig. (45): Deflection, Case B, Harp.

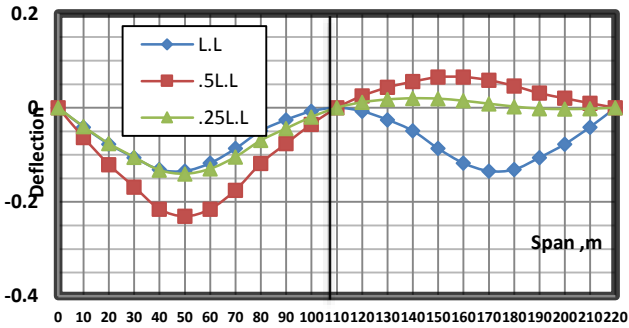

Fig. (42): Deflection, Case C, Radiating.

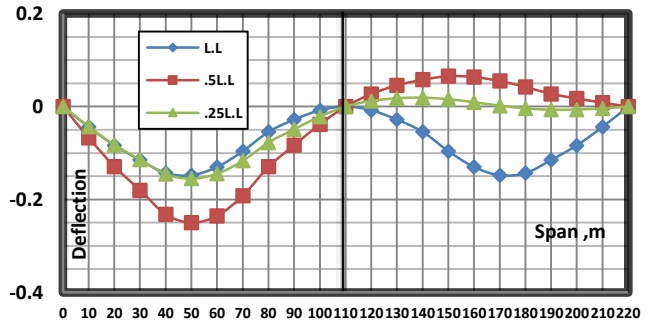

Fig. (46): Deflection, Case C, Harp.

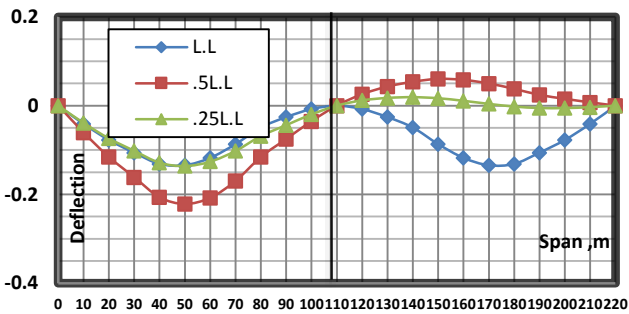

Fig. (43): Deflection, Case D, Radiating.

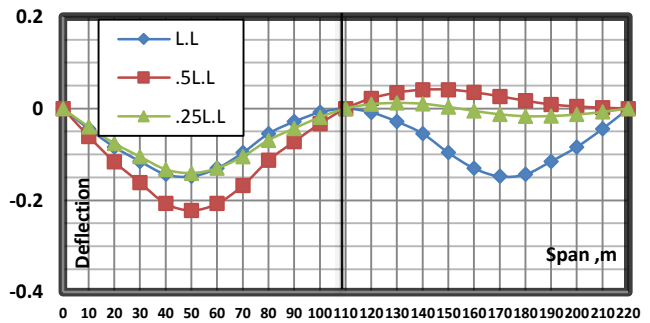

Fig. (47): Deflection, Case D, Harp.

REFERENCES

- [1] Buchholdt, H. A., "an introduction to cable roof structures", Cambridge University Press, (1985).
- [2] STRUCTURAL DESIGN OF CABLE-STAYED BRIDGES Carlos Miguel Cabeçadas Calado Technical Higher Institute - Technical University of Lisbon, Portugal, Outubro 2011.
- [3] Troitsky, M. S., "cable- stayed bridges, Theory and design, "CrosbyLockwood Staples, London, 2nd ed. (1989).
- [4] Monforton, G. R., and El-Hakim, N. M., "Analysis of Truss-Cable Structures "Computers & Structures, Vol. 11, pp. 327-335, (1980).
- [5] El-madawy, M.T.A, "Arrangement of Cables in Cable-Stayed Bridges", M.Sc. Thesis, Mansoura University, Mansoura.
- [6] Frederick S. Merritt: Structural Steel Designers' Handbook: Copyright by McGraw-Hill, Int., 1972.
- [7] Naguib, M. "Influence of Connections between towers and Floor Beams in Cable-Supported towers and Floor Beams in Cable-Supported Bridges", Mansoura Engineering Journal (MEJ), Vol. 28, No. 4, pp. c.14-c.29, December (2003).
- [8] Naguib, M. "Buckling Strength and Dynamic Response of Guyed Towers" Ph.D. Thesis, Struct. Eng. Dept., Mansoura University, Mansoura, Egypt, 1989.
- [9] Naguib, M. "Single and Double Planes of Cables in Harp Cable Stayed Bridges", Mansoura Engineering Journal (MEJ), Vol. 30, No. 3, September 2005.
- [10] Stefanou, G. D., Moossavi, E., Bishop, S., and Koliopoulos, P., " Conjugate gradients for calculating the response of large cable nets to static loads" Computers & Structures, Vol. 49, No.5, pp. 843-848, (1993).
- [11] Buchholdt, H. A., " Tension structures", struck. Engorge. Vol. 48, No. 2, pp. 45-54., February (1970).
- [12] Naguib, M "TWO SPANS Cable Stayed Bridges", Mansoura Engineering Journal (MEJ), Vol. 30, No. 4, December2005.
- [13] Tezcan, S.S., "Stiffness Analysis of Suspension Bridges by Iteration Proceeding Symposium on Suspension Bridges", National Laboratory of Civil Engineering, Lisbon, Portugal, November 1966.
- [14] Selim, Mohammed Shaaban Ibrahim. "Dynamic analysis of cable stayed railway bridges due to different speeds", M.Sc. Thesis, Mansoura University, Mansoura, 2015.