

BIT ERROR RATE PERFORMANCE OF MULTI CARRIER SYSTEM UTILISING QPSK AND OQPSK WITH GUARD INTERVAL

I. A. Z. Qatawneh, Mutah University
Faculty of Engineering, Dept. of Electrical Engineering
Mutah AL-Karak, postal code : 61710, Jordan.

الاداء حسب معدل الخطأ لنظام الموجات الحاملة المتعددة (MC) المستخدم للتبديل الزاوي المتعامد المتأخر (Offset QPSK) والتبديل بالزاوي المتعامد نوع (QPSK) باستخدام فترة زمنية للحماية وكاشف تفاضلي مترامن وقناة نقل ذات ضوضاء بيضاء مضافة جاوسيه التوزيع وقناة ذات خفوت مسطح واخرى ذات خفوت بمسارين من اجل تحسين النظام (Offset QPSK) ضد تأثيرات أي من القنوات.

الملخص:

ان تقنية الارسال ذو الترددات الحاملة المتعددة المعروف باسم التقسيم الترددي المضاعف (MC) استعمل في عقد الستينات (1960's) من القرن الماضي لغرض ارسال حزم البيانات من النطاق القاعدي. اما الآن فهناك تطبيقان رئيسيان للتقسيم الترددي المضاعف: التطبيق الاول هو لدائرة المشترك الرقمية ذات السرعة العالية والتطبيق الثاني لاغراض البث الاذاعي للاشارات المسموعة والمرئية. وسوف نقدم هنا استخدامات التقسيم الترددي المضاعف المتعامد لتطبيقات اللاسلكي ذات معدل المعلومات العالي. ولغرض تحسين كفاءة الطيف، استخدم نظام التبديل الزاوي المتعامد المتأخر (OQPSK) لتضمين الترددات الحاملة توازنا بدلا من التضميني المتعامد QPSK المعتاد باستخدام التبديل الزاوي المتعامد. تتحرى هذه الورقة موضوع معدل الخطأ (BER) في المعلومات لنظام التقسيم الترددي المضاعف الذي يستخدم مبدأ التضمين المقداري المتعامد (OQPSK) باستخدام فترة زمنية للحماية يترونظام كشف تزامني وقناة نقل مسطحة التردد وكذلك قناة نقل بمسارين وذات خفوت Fading ومبدأ كشف التضميني التفاضلي المتشابهه (منسجم الطور) في التردد وعندما تكون قنوات الارسال خالية من الخفوت او ذات خفوت. استخدمت طريقة مونت كارلو في البحث لاغراض المحاكاة في تحليل النظام ودراسة خواصه المطلوبة. اشتمل البحث ايضا على مقارنة هذا النظام مع النظام التقليدي المكافئ الذي يعتمد التردد الحامل المنفرد.

التقسيم الترددي المضاعف المتعامد، القنوات ذات الخفوت، التضميني المقداري المتعامد، الاتصالات اللاسلكية والجوالة.

ABSTRACT

The multicarrier (MC) transmission technique was devised in the 1960's for voiceband data transmission [1,2]. Today there are two principle multi carrier applications. one is for the high speed digital subscriber loop and the other is for the broadcasting of digital audio and video signals [3,4,5]. In this work the use of multi carriers for high-bit rate wireless applications are considered. The bit error rate (BER) performance of multi carriers with quadrature phase shift keying (QPSK) and offset quadrature phase shift keying (OQPSK)[6,7] with guard interval in a fading environment is considered via the use of Monte Carlo simulation methods. BER results are presented for OQPSK using guard interval to immunity the multipath delay for frequency Rayleigh fading channels and for two-path fading channels in the presence of additive white Gaussian noise (AWGN).

1. Multi carrier system Overview and Signal Generation

In this work the use of Multi Carrier System (MCS) techniques is considered to achieve high bit rate wireless communications. The discrete Fourier transform (DFT) enables the efficient generation and demodulation of multicarrier system [8,9].

Figure 1 shows the block diagram of the MC system. The binary input sequence is applied to the OQPSK baseband modulator, the output of the modulator is a complex baseband Inphase (I) and Quadrature (Q) symbol sequence. For the simulations where coherent demodulation is being investigated, in either case, the complex symbol sequence is formed into parallel blocks by the serial to parallel (S/P) converter before applying it to the Inverse Discrete Fourier Transform (IDFT). IDFT generates the multi carrier signal. The resulting output of the IDFT are consisting of blocks of N complex samples which is then converted into a serial format by the parallel to serial converter (P/S) which is applied to guard add circuit before quadrature up conversion to radio frequency (RF). then the signal is ready for transmission. For the simulations presented here, $N=16$ (16 carriers).

At the receiver, the incoming signal is quadrature down converted before applying it to guard remove circuit. The output of the guard remove circuit is a complex baseband received signal. This complex signal is formed into blocks of length N samples by the serial to parallel converter (S/P) before being Discrete Fourier transformed (DFT) [11] to yield a block of N received complex symbols. These symbols are then converted back in to a serial binary format by the OQPSK demodulator. When coherent demodulation is being performed, the complex symbols at the output of the P/S converter are then converted back in to the binary serial format by the demodulator. For simulation purposes a pseudo random binary sequence (PRBS) is applied to the OQPSK modulator and an error counter is connected to the serial data output and also to the PRBS source which acts as a reference. In a channel with delay spread, it is often necessary to add a guard period to the transmitted symbols. By preceding each symbol by a guard period it is possible to absorb the inter-symbol interference. The guard period must be of limited duration [9], because although a longer guard period gives a more rugged system, it imposes a penalty because of the power required for its transmission.

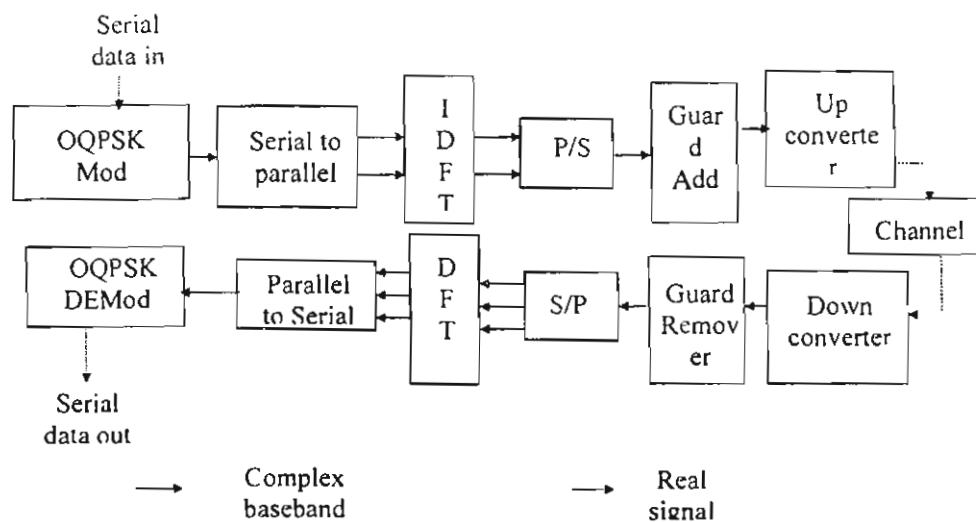

Figure 1. Multicarrier system simulation

2. Fading Channel Models

In this work the mobile and wireless applications are considered, for this reason the appropriate radio channel models are chosen to support the simulation process for this work. A typical channel model in land mobile radio is known as frequency flat Rayleigh fading. This model is suitable for modelling urban

areas that are characterised by many obstructions, e.g., buildings, surrounding the mobile station where a line of sight path does not exist. In suburban areas, a line of sight path may exist between transmitter and receiver and this will give rise to Rician fading. Rician fading may be characterized by a factor which is defined as the power ratio of the specular (line of sight or direct path) component to the diffuse components. This ratio α , defines how near to Rayleigh statistics the channel is. In fact, when $\alpha = 0$ there is a Rayleigh fading, and there is no fading at all when $\alpha = \infty$. The rate of change of the fading is defined by the Doppler rate. The Doppler rate is proportional to the velocity of the mobile station and the frequency of operation. The normalised Doppler rate is given by $f_d T_s$ where f_d is the maximum Doppler rate and T_s is the MC symbol duration. For this work simulations, the symbol duration is equal to one second so that the normalised Doppler rate is equal to the Doppler rate. In general, normalized Doppler rates less than 0.01 are applicable to most systems[8].

A more complex propagation model includes many discrete scatters, where each propagation path may have a different amplitude, propagation delay and Doppler shift. When the components of a signal are received with different delays, the phase difference between them is a function of the frequency of the components. Thus the transmitted signal will experience a channel with a non-flat frequency response, which also varies with time. This type of channel is said to be frequency selective and is usually modelled as a tapped delay line, where the number of taps is equal to the number of discrete delayed paths. Clearly, the effect of the tapped delay line is to introduce overlap between the transmitted symbols. This form of degradation is known as intersymbol interference (ISI). One simple frequency selective channel model is known as the two path fading channel. In this model the first arriving path experiences Rician fading and the second arriving path (which has a delay set by the delay parameter, z) experiences Rayleigh fading. In addition, we define a ratio (d) between the power in the first path and the power in the second path. In our work, $d = 15$ and the ratio α for the Rician fading path is equal to 15 for all the simulations. Fig.2 shows the simulation model. Fig.3 shows a frequency selective fading channel model for two path fading channel [10].

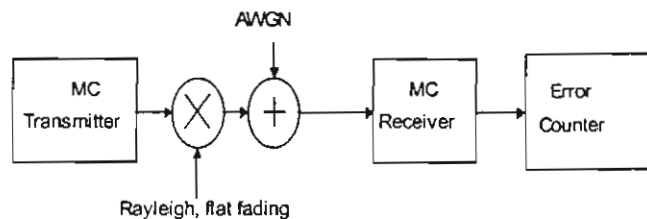

Fig.2. Simulation model

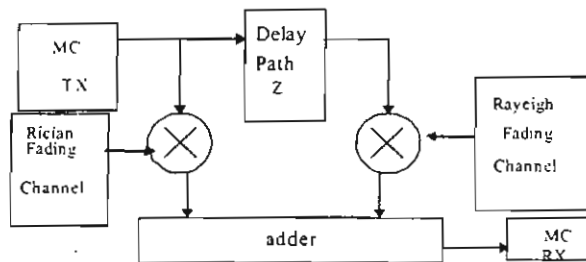

Fig.3 Frequency selective fading channel model for two path fading channel model

3. Transmitted signal with Guard period

In the presence of inter symbol interference caused by the transmission channel, the properties of MC between the signals are no longer maintained. One can approach asymptotically towards a solution to the problem of channel selectivity by increasing indefinitely the number of carriers [5, 10]. However,

this method is limited by the temporal coherence of the channel (Doppler effect) or simply by the technological limitation of the phase noise of the oscillators.

The second solution sacrifices some of the emitted energy by preceding each symbol by a guard period to absorb the inter-symbol interference. This is achieved using the guard period add block shown in Fig.4. The guard period must be of limited duration [10], because although a longer guard period gives a more rugged system, it imposes a penalty because of the power required to transmit this guard period. Let Δ be the guard period. Therefore the duration of transmitted signal is given by $t_s = \Delta + T_s$. The guard period is added by taking the last four samples of the 16 time domain samples at the output of the IDFT and then inserting them in front of the 16 original samples. Consequently, the total number of transmitted samples is now 20 samples per symbol block as shown in Fig.4.

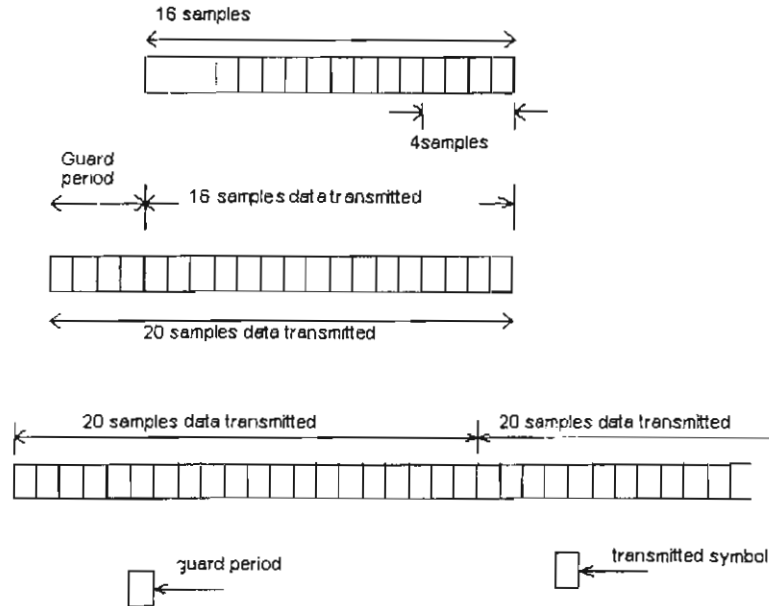

Fig. 4. Addition of guard period

The complementary block in the transmitter is the guard period add block which performs the task depicted in Fig. 4. The implementation of the guard period remove block is shown in Fig. 5. The resulting output of the guard remove is 16 samples per symbol.

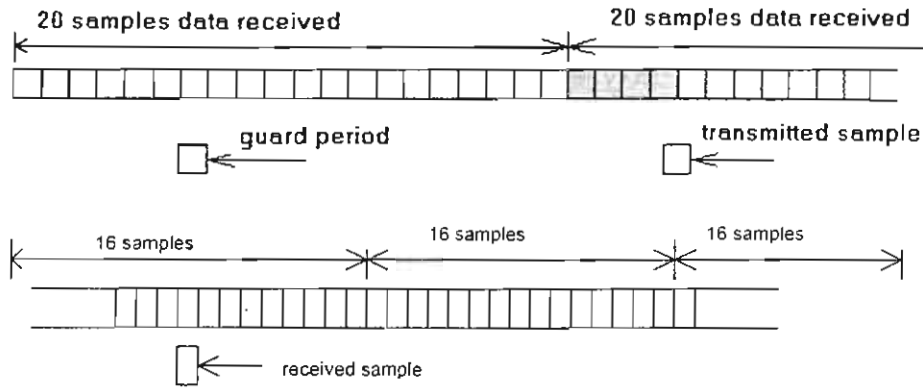

Fig.5 Guard period remove.

4. Two path fading channels

4.1 Performance of MC-OQPSK with magnitude two path fading channels

In mobile communication systems, the errors are introduced not only by noise, but also by intersymbol interference. These later errors cannot be eliminated by simply increasing the transmitter power. The error rate due to ISI can be appreciable even if the delay spread is much smaller than the bit duration [8]. In this work a two-path fading channel model is being implemented Using the SPW simulator [3]. Fig. 6 shows the BER performance for MC/OQPSK with a guard period in the presence of AWGN for the magnitude only two-path fading model, Doppler rate 0.1 Hz. for various signal delays in the second path. For example $z = -1$ means a delay of one sample period. for this work. 16 carrier simulations and the delay corresponds with 1/16 of the transmitted symbol period. The first path is Rician with $\alpha = 15$ and the ratio of power in the first path to the power in the second path (d) is 15. For the designed channel it can be observed that the BER is depending on the second path delay.

Figures 6 and Figures 7 show the effects of removing the symbol guard period when operating over the two-path magnitude fading channel only. For both values of path delay, it can be seen that the removal of the guard period has given rise to irreducible BERs.

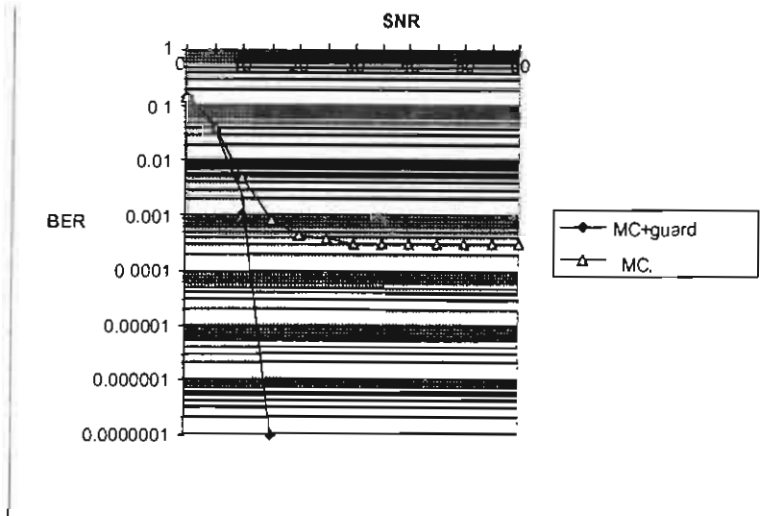

Fig. 6 BER performance for MC/OQPSK with and without a guard period in presence of AWGN for magnitude two path fading , Doppler frequency $f_d = 0.1$ Hz, $\alpha = 15$, $d = 15$, and a second path delay $z = -1$ samples.

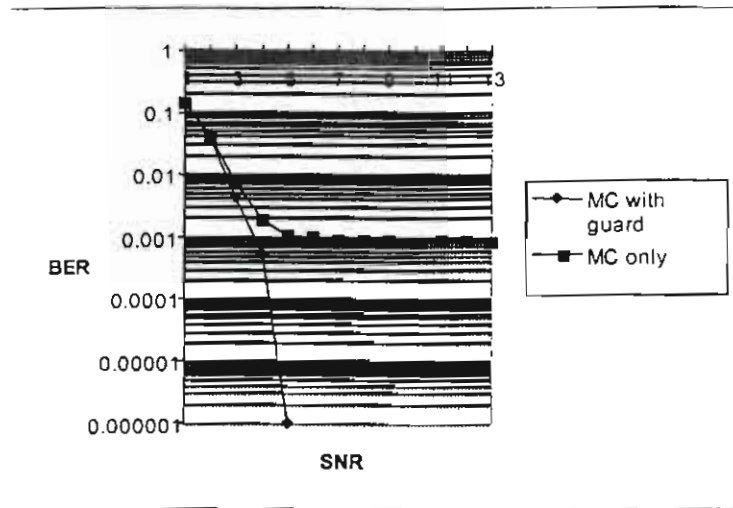

Fig 7 BER performance for MC/OQPSK with and without a guard period in presence of AWGN for magnitude only two path fading , Doppler frequency $f_d = 0.1$ Hz, $a = 15$, $d = 15$, and a second path delay $z = -3$ samples.

Fig. 8 Shows the BER performance for MC/OQPSK with and without a guard period as compared with MC/QPSK in presence of AWGN for two cases with and without magnitude for two path fading , Doppler frequency $f_d = 0.1$ Hz, $a = 15$, $d = 15$, and a second path delay $z = -1$ samples. The results for BER MC/OQPSK with a guard period in magnitude only for two path fading. It is similar to Guassain, but the results for MC/OQPSK without a guard period and magnitude in two path fading becomes worse, but the worst result for the case MC/QPSK without a guard period and without magnitude two path fading. This can be explained due to multi path delay in the channel, also when dealing with magnitude in two path fading , this means that it is dealt with magnitude changes in the channel, and not dealt with phase changes in the channel

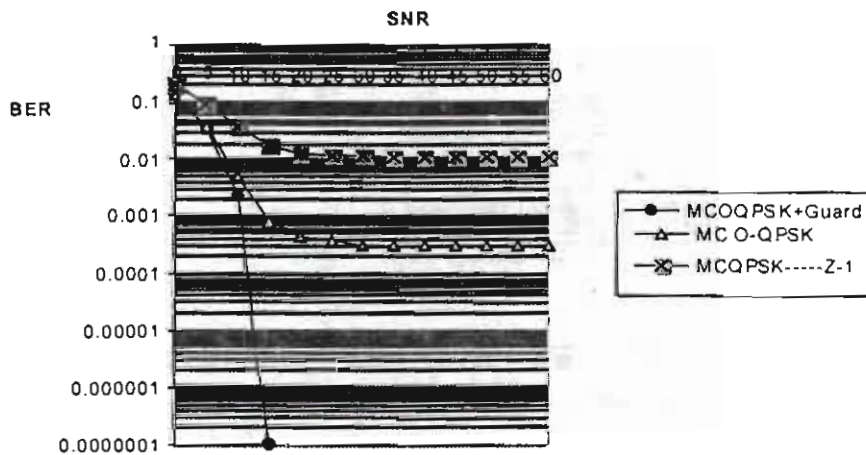

Fig 8. BER performance for MC/OQPSK with and without a guard period in presence of AWGN with and without magnitude two path fading . Doppler frequency $f_d = 0.1$ Hz. $a=15$. $d = 15$. and a second path delay $z = -1$ samples.

Fig. 9 Shows the BER performance for MC/OQPSK with and without a guard period as compared with MC/QPSK in presence of AWGN with and without magnitude two path fading . Doppler frequency $f_d = 0.1$ Hz. $a=15$. $d = 15$. and a second path delay $z = -3$ samples. The results for BER using MC/OQPSK with a guard period in magnitude only for two path fading seems to be similar to Guassain, but the results for BER using MC/OQPSK without a guard period and with magnitude two path fading becomes worse, but the result becomes worse for MC/QPSK if we do not use a guard period and we do not have magnitude two path fading . This may be explained due to the increasing multi path delay($z = -3$) in the channel. also when dealing magnitude two path fading . this means that dealing with magnitude changes in the channel and not dealing with phase changes in the channel

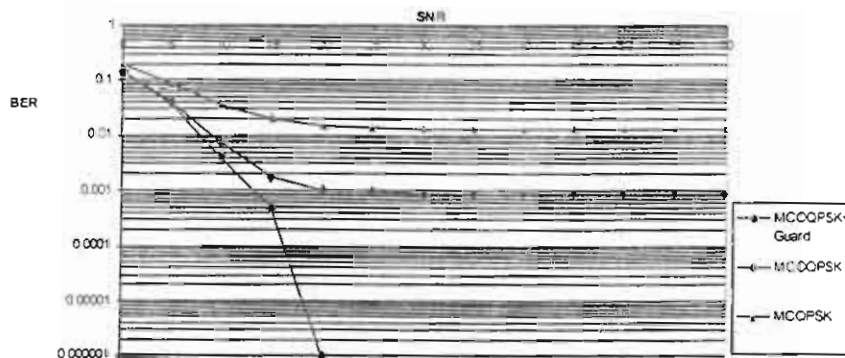

Fig.9 BER performance for MC/OQPSK with and without a guard period in presence of AWGN with and without magnitude two path fading . Doppler frequency $f_d = 0.1$ Hz. $a=15$. $d = 15$. and a second path delay $z = -3$ samples.

4.2 Performance of MC/OQPSK with a guard period in AWGN with two-path channel fading.

To overcome the problem of the multi path delay, in this work a guard period was inserted between successive transmitted symbols as explained in part -3. To reduce the problem of multi path delay a guard period is inserted into the transmitted symbols. which is in this work simulation is equal to 1/4 of the symbol period. Thus each transmitted symbol has its duration increased from 16 to 20 sample periods. This guard period is used to absorb the signal delay induced by the two path fading channel. The simulation results shown in Fig 10, 11, and Fig 12 shows an improvement in performance of the OFDM/OQPSK system due to the addition of the guard period for various values of second path delay.

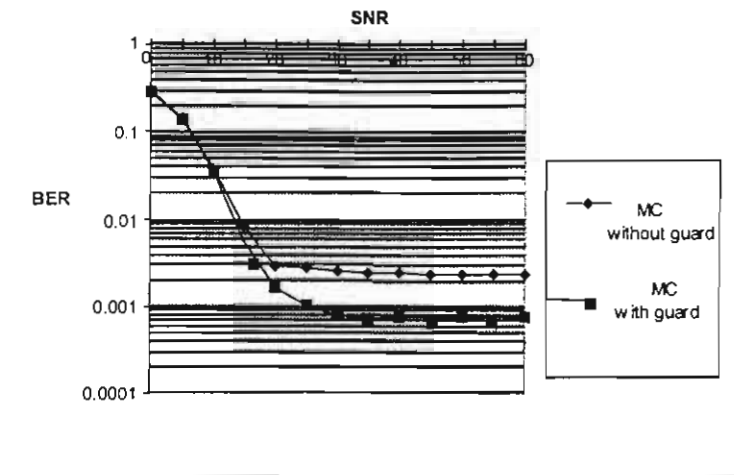

Fig. 10 BER performance for MC / OQPSK with and without a guard period for a second path of delay $z = -1$, $a = 15$, $d = 15$, $f_d = 0.1$ Hz.

From these graphs it can be seen that the performance improvement in terms of values of irreducible BER decrease as the delay between first and second paths rise towards that corresponding with the guard period. It is clear that the modest BER performance levels achieved when the second path delay exceeds one sample period are unacceptable without further measures being applied e.g., forward error correction, a change in the way the serial symbols are multiplexed onto the parallel carriers or an increase in the number of carriers to further increase the transmitted symbol period. It should be also noted that the Doppler rate of 0.1 Hz used in these simulations is much more severe than is likely to be experienced in most indoor channels.

Fig. 13 summarises the BER results for MC/OQPSK with a guard period in the presence of AWGN and two-path fading for various second path delays. All these results have a Rician fading power ratio of $a = 15$ for the first path and a power ratio $d = 15$ between first and second paths and a Doppler rate $f_d = 0.1$ Hz. These simulation results show that, the irreducible BER increases when the delay between the first and second arriving paths was increased. When the delay is equal to seven sample periods, the BER performance is very poor because the channel delay is now in excess of the guard period.

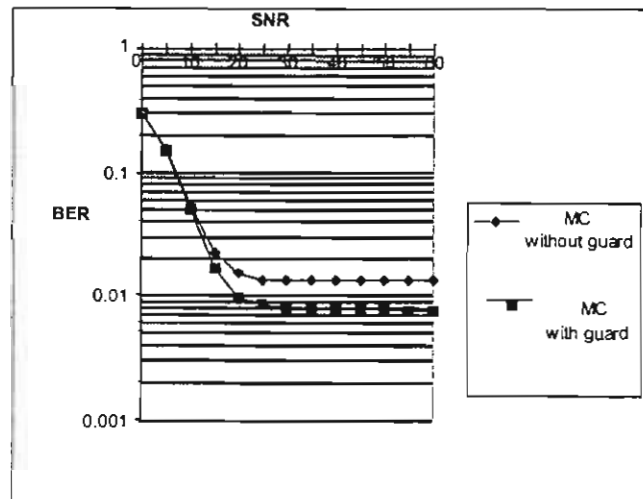

Fig. 11 BER performance for MC/OQPSK with and without a guard period for a second path of delay of $z = -3$, $a = 10$, $d = 10$, $fd = 0.1$ Hz.

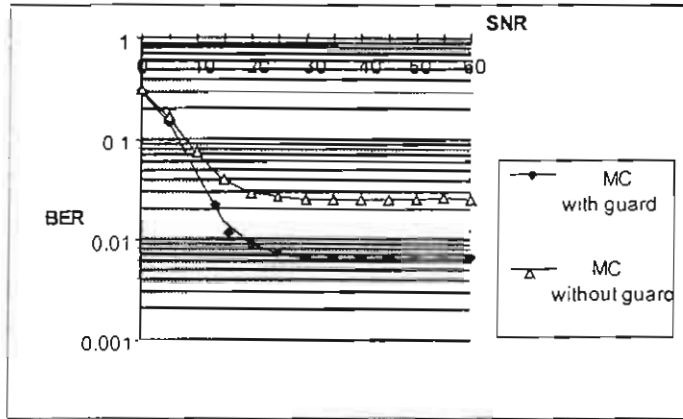

Fig. 12 BER performance for MC/OQPSK with and without a guard period for a second path of delay of $z = -5$, $a = 15$, $d = 15$, $fd = 0.1$ Hz.

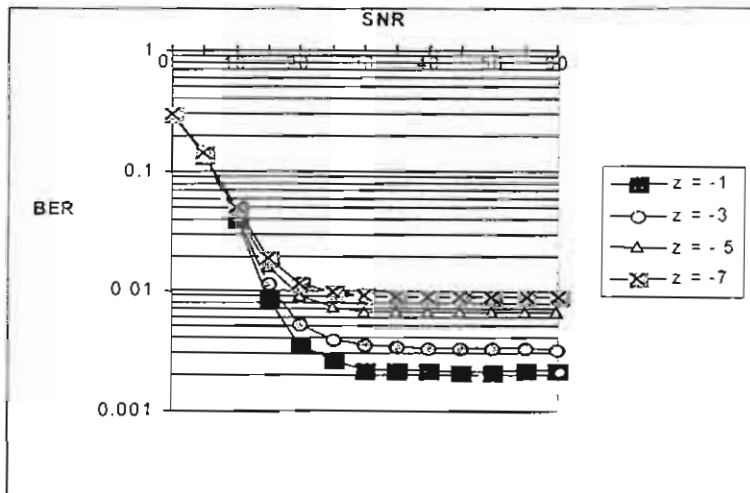

Fig. 13 BER performance for MC/OQPSK with a guard period in the presence of AWGN and two-path fading channel for various second path delays. $a = 15$, $d = 15$, $fd = 0.1$ Hz.

Conclusion

In this paper, the performance of MC/OQPSK has been investigated in AWGN, flat Rayleigh Rician fading and two-path fading channels. With a specular ($a = 15$) Rician channel at a normalised Doppler rate of 0.1, the degradation from Rayleigh channel ($a = 0$) gives rise to an unacceptable irreducible BER of about 0.01. However, for the indoor or microcellular environment a direct path is likely to lead to less hostile channels than flat Rayleigh fading. With two-path fading and a normalised Doppler rate of 0.1, the BER performance is not acceptable, even at low values of second path delay. However, in the indoor or microcellular channel, the normalised Doppler rate is likely to be lower than the 0.1 used in the simulations. This will improve the performance of the coherent demodulator. For channels with delay spread, the BER performance for coherent demodulation of multi carrier is poor at a Doppler rate of 0.1 Hz, though the use of a guard period does improve things for low values of second path delay.

References

- [1] Minoru Okada, Shinsuka and Norihiko Morinaga "Bit Error Rate Performance of Orthogonal Multi Carrier Modulation Radio Transmission Systems" IEICE Trans. Commun, Vol.76.No.2 February 1993.
- [2] Carl W.Baum and Kieth F.Conner " A Multi Carrier Transmission Scheme for Wireless Local Communications" IEEE Journal on selected areas in communications Vol.14.No.3. April 1996
- [3] I.A.Z. Qataweh. " The Use of Orthogonal Frequency Division Multiplexing (OFDM) techniques in Mobile Broadband Applications. PhD thesis, University of Huddersfield. July 1997
- [4] R. W.Chang. "Synthesis of Band-limited Orthogonal Signals for Multi channel Data Transmission,"
Bell System. Tech. J., Vol. 45, pp. 1775-1796, Dec. 1966.
- [5] P. Shelswell, " The COFDM Modulation System : the Heart of Digital Audio Broadcasting" Electronics & Communication Engineering Journal, pp. 127-136, June 1995.
- [6] H. Sari et. al., "Transmission Techniques for Digital Terrestrial TV Broadcasting," IEEE Communications Magazine, Feb. 1995, pp. 100-109.
- [7] S. Benedetto, E. Biglieri, V. Castelenni "Digital Transmission Theory", Prentice- Hall International Limited, U.K. London, 1989.
- [8] Selaka B.Bulumulla, Saleem A.Kassam and Santosh S.Venkatesh."A Systematic Approach to Detecting OFDM Signals in Fading Channels" IEEE Transactions on Communications. Vol.48.No.5. May 2000 .
- [9] S. B. Weinstein, "Data Transmission by Frequency Division Multiplexing using the Discrete Fourier Transform," IEEE Transactions on Communication Technology, Vol. Com -19. No. 5. October 1971
- [10] D. Pommier, Y. Wu". "Interleaving or Spectrum Spreading in Digital Radio Intended for Vehicles", EBU Review - Technical No. 217, pp. 128- 142, June 1986.
- [11] John A.C Bingham "Multi Carrier Modulation for Data Transmission : An Idea Whose Time Has Come" IEEE Communication magazine, May 1990.